

ECOSMART BOXER AHU STANDARD CONFIGURATIONS

COMPLETE PACKAGED AIR HANDLING UNITS WITH ALL THE NECESSARY CONTROLS.

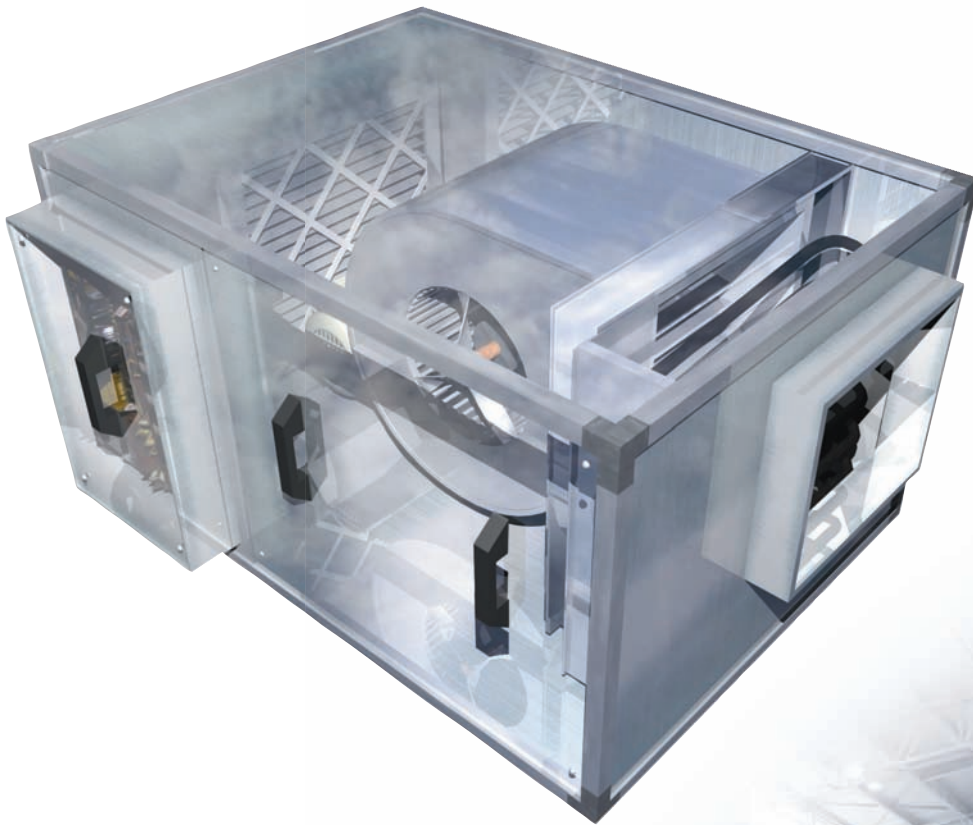

BENEFITS

VERY QUIET

25mm double skinned panels provide better acoustic and thermal properties over conventional AHU's.

REDUCE INSTALLATION TIME

All components are pre-assembled, wired and tested at the Nuair manufacturing facility. Units are delivered conveniently in sections for easy site assembly.

SIMPLE PRECISE COMMISSIONING

Minimum and maximum ventilation rates precisely set and limited at AHU requiring no throttling dampers.

ENERGY EFFICIENT

All models have Ecosmart controls built in, which provide the most energy efficient and cost effective solution.

PART L AND ENERGY EFFICIENT

Fan impellers are selected for optimum efficiency and noise characteristics. Motors are IE2 to BS 5000 direct drive and high efficiency belt drive.

IMPROVED LIFE CYCLE/NO SYSTEM OVERLOADS

Ecosmart is pre-programmed to automatically give a soft start function which prevents electrical overloading and minimises mechanical wear.

LONG LASTING

Each section is manufactured from a highly rigid pentapost framework with heavy gauge AluzincY, corrosion resistant steel panels.

CONSTANT PRESSURE CONTROL AVAILABLE

For further information contact Nuair.

COIL OPTIONS

DX & chilled water coils are available, call Nuair for further details.

Note: Undressed coils are also available.

WARRANTY

Ecosmart Boxer has a 5 year warranty.

ANCILLARIES & COMPONENT OPTIONS:

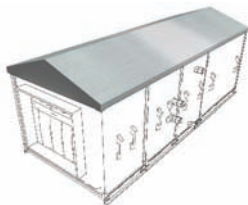

Weather terminals.



Silencers.

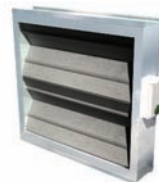

Dampers.



Monometer.



Vertical and horizontal heat exchangers.



Base frames.

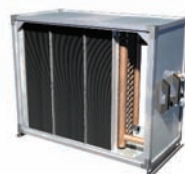

DX Coils.



Sizes 3 - 7 = G4 bag or G4 bag & F7 bag.

PERFORMANCE - ECOSMART BOXER SIZES 3 - 7

Ecosmart Boxer supply unit filter and heating coil

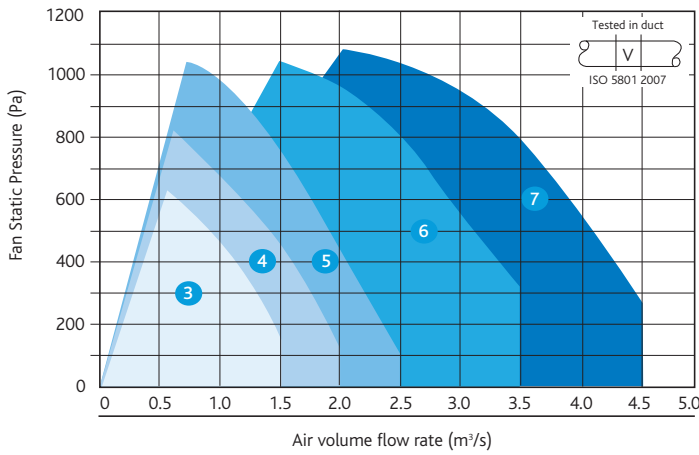

Ecosmart Boxer Supply unit filter and heating and cooling coil

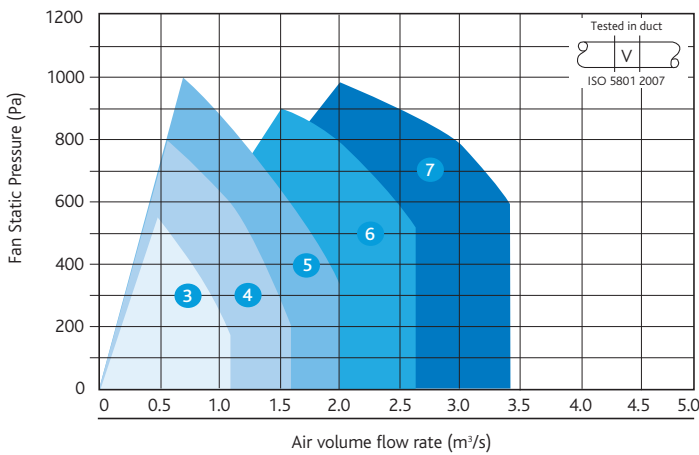

Ecosmart Boxer fan unit only

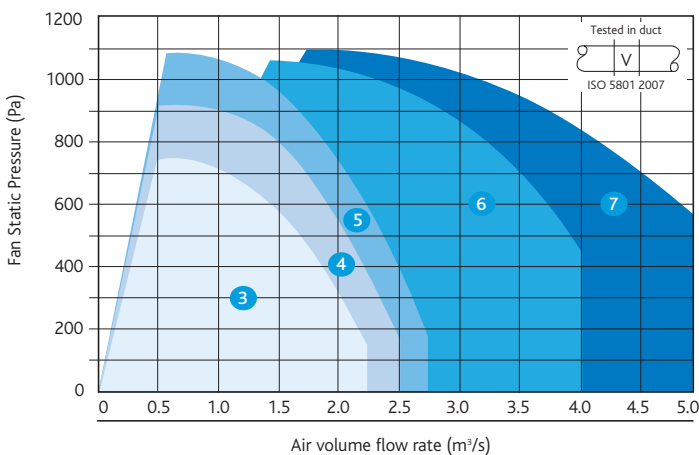

N.B. Unit air volume flowrates are calculated by component velocity.

Casing



Ecosmart Boxer sizes 3 - 7

Code descriptions

ESBH S - 3 - LC

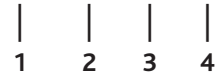

1. Ecosmart Boxer range
2. S = Supply
EX = Extract
3. Size 3 - 7
4. L = Low Pressure hot water heater battery
LC = Low Pressure hot water heater battery and CHCW chilled water cooling coil
LD = Low Pressure hot water heater battery and DX cooling coil
ED = Electric heater battery and
DX = Direct expansion (refrigerant type coil)

Note: If no Ecosmart control is required example code would be: BHS3NC-LC.

If fan control only is required (undressed coils) example code would be: BHS3FC-LC.

Please note: Sizes 3 - 7 do not have filters included as standard.

AIR HANDLING UNITS (AHU'S)

ECOSMART BOXER

TECHNICAL INFORMATION

PERFORMANCE - ECOSMART BOXER SIZES 3 - 7

ELECTRICAL & SOUND

Curve	Motor Rating (kW)	Electric Coil Data (kW)	Fan Input Power (watts)	RPM	Pole	Phase	Type	Ducted sound power levels dB re 1pW Data							Breakout dBA@ 3m
								125	250	500	1K	2K	4K	8K	
3	2.2	27	1.584	1920	4	3	I inlet	84	81	82	76	73	67	62	40
							O outlet	87	82	81	75	71	66	62	
4	3	36	2.407	2160	2	3	I inlet	87	84	85	79	76	70	65	43
							O outlet	90	85	84	78	74	69	65	
5	4	54	3.132	2340	2	3	I inlet	89	86	87	81	78	72	67	45
							O outlet	92	87	86	80	76	71	67	
6	4	54	4.035	1780	4	3	I inlet	84	86	83	80	77	72	65	43
							O outlet	84	84	84	85	80	74	66	
7	5.5	54	5.177	1630	4	3	I inlet	86	91	85	81	79	74	69	45
							O outlet	87	90	87	86	82	75	70	

CODING

Curve	Extract Code	Supply with LPHW Heater Code	Supply with LPHW Heater & Cooling Coil Code	Supply with LPHW Heater & DX Cooling Coil Code	FLC (amps)	SC (amps)
3	ESBHEX3	ESBHS3-L	ESBHS3-LC	ESBHS3-LD	5	5
4	ESBHEX4	ESBHS4-L	ESBHS4-LC	ESBHS4-LD	7	7
5	ESBHEX5	ESBHS5-L	ESBHS5-LC	ESBHS5-LD	8	8
6	ESBHEX6	ESBHS6-L	ESBHS6-LC	ESBHS6-LD	8.5	8.5
7	ESBHEX7	ESBHS7-L	ESBHS7-LC	ESBHS7-LD	11	11

CODING

Curve	Supply with Electric Heater & DX Cooling Coil Code	Supply with Electric Heater Code	Supply with Electric Heater & Cooling Coil Code	FLC (amps)	SC (amps)
3	ESBHS3-ED	ESBHS3-E	ESBHS3-EC	5	27
4	ESBHS4-ED	ESBHS4-E	ESBHS4-EC	5.7	7
5	ESBHS5-ED	ESBHS5-E	ESBHS5-EC	8.3	8
6	ESBHS6-ED	ESBHS6-E	ESBHS6-EC	83.5	8.5
7	ESBHS7-ED	ESBHS7-E	ESBHS7-EC	86	11

DX COIL DATA

Unit Size	Max Air Flow m³/s	kW Rating R407C	Evap. temp deg C	PD through Coil KPa	Conn size
3	1.0	19	5	18	2x12&22od
4	1.4	27	5	15	2x12&28od
5	1.9	37	5	13	2x22&35od
6	2.5	48	5	11	2x22&35od
7	3.5	68	5	11	2x22&42od

Flow valve setting.

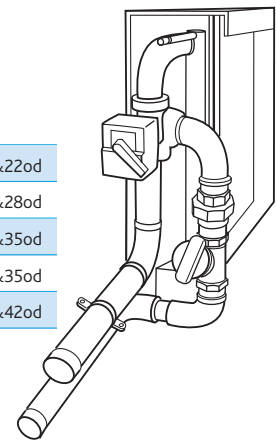

Z FACTORS FOR ANCILLARIES

Casing Module	1	2	3	4	5	6	7
Silencer	102	41	20	11	8	3.1	2
Damper	61	25	12	6.8	4.8	1.9	1.2
Frost coil LPHW	122	50	23	14	9.6	3.8	2.4
Frost coil electric	122	50	23	14	9.6	3.8	2.4
Weather cowl	61	25	12	6.8	4.8	1.9	1.2
Plate heat exchanger	612	148	117	68	48	1.9	12
H or V							

Unit Size	Frost Coils		Cooling Coils		Heating Coils	
	In	Out	In	Out	In	Out
3	1 BSP	1 BSP	1.25BSP	1.25BSP	1.25BSP	1.25BSP
4	1 BSP	1 BSP	1.25BSP	1.25BSP	1.5BSP	1.5BSP
5	1.25BSP	1.25BSP	1.5BSP	1.5BSP	2 BSP	2 BSP
6	1.25BSP	1.25BSP	2 BSP	2 BSP	2 BSP	2 BSP
7	1.5BSP	1.5BSP	2 BSP	2 BSP	2 BSP	2 BSP

For wiring diagrams refer to pages 110.

DIMENSIONS AND CONFIGURATIONS

Ecosmart BOXER size 3 - 7

DIMENSIONS (mm) & WEIGHTS (KG)

Size	ESBHEX*		ESBHS*L/E		ESBHS* Heating & Cooling							
	L	W	L	W	L	W	B	C	E	F	G	H
3	1200	199	2400	402	3000	529	800	800	373	403	600	350
4	1200	243	2400	442	3000	590	1000	800	373	535	600	450
5	1200	255	2400	490	3000	600	1000	1000	373	535	600	450
6	1500	390	2700	702	3300	858	1300	1000	557	479	600	500
7	1500	507	2700	913	3300	1115	1300	1300	638	638	600	500

NB: Units are handed left hand side as standard. (L=Length, W=Weight).
Right hand side is available on request.

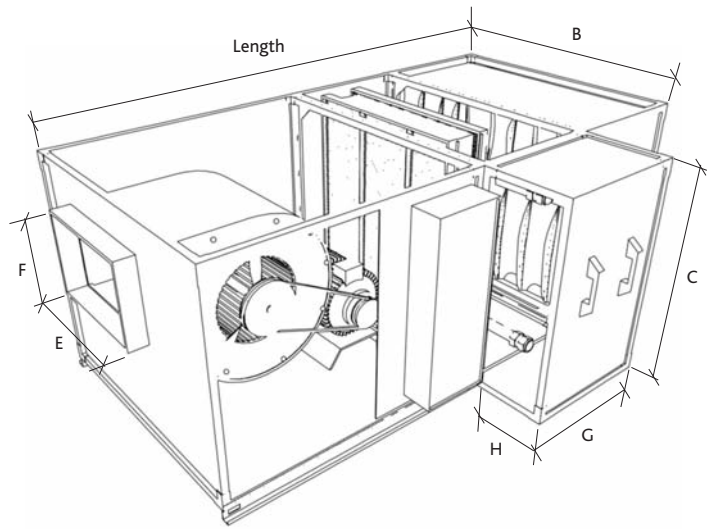

Airflow



Airflow

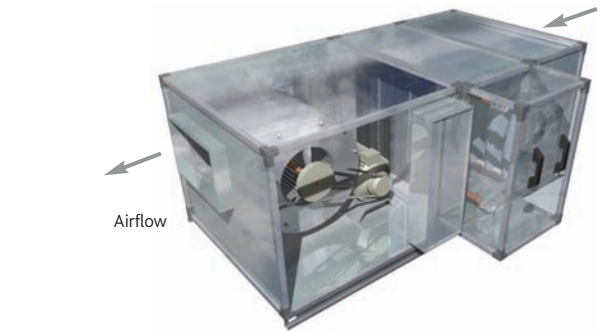

Model shown: size 7 (right hand with cooling coil).

Model shown: size 7 (left hand with cooling coil).

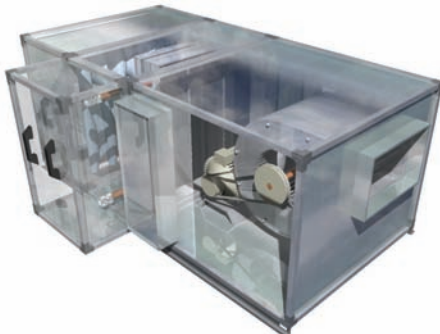

Model shown: size 7 (right hand with DX cooling coil).

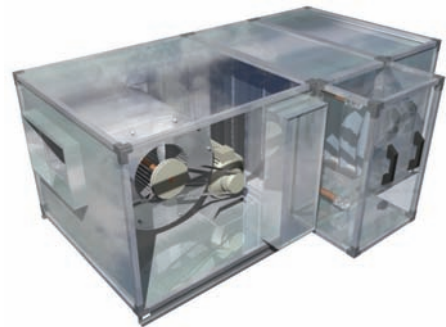

Model shown: size 7 (left hand with DX cooling coil).

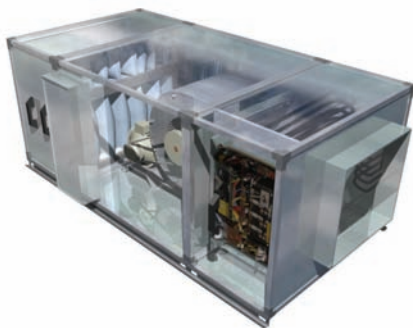

Model shown: size 7 (right hand supply with electric heater).



Model shown: size 7 (left hand supply with electric heater).

ECOSMART BOXER SIZES 3 - 7



Model shown: size 7 (right hand supply with electric heater and cooling coil).



Model shown: size 7 (left hand supply with electric heater and cooling coil).



Model shown: size 7 (right hand supply with electric heater and DX coil).



Model shown: size 7 (left hand supply with electric heater and DX coil).

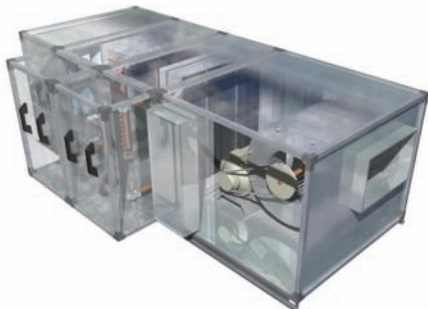

Model shown: size 7 (right hand supply with LPHW heater).



Model shown: size 7 (left hand supply with LPHW heater).



Model shown: size 7 (right hand supply with LPHW heater and cooling coil).



Model shown: size 7 (left hand supply with LPHW heater and cooling coil).

ECOSMART BOXER SIZES 3 - 7

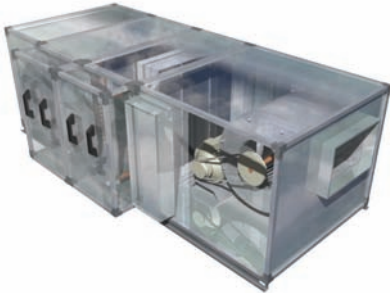

Model shown: size 7 (right hand supply with LPHW heater and DX cooling coil).



Model shown: size 7 (left hand supply with LPHW heater and DX cooling coil).

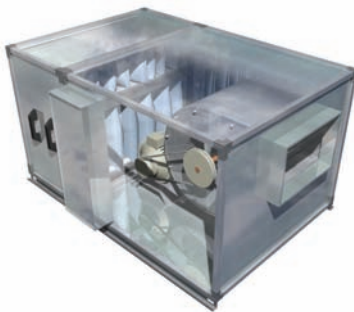

Model shown: size 7 (right hand with extract).

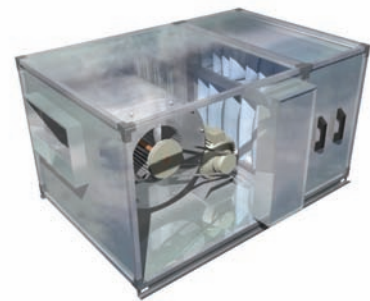

Model shown: size 7 (left hand with extract).

Please note: Sizes 3 - 7 do not have filters included as standard.

AIR HANDLING UNITS (AHU'S)

ECOSMART BOXER COILS FOR LPHW

TECHNICAL INFORMATION

ECOSMART BOXER Size 3

Air Volume Flow rate (m³/s)

2 ROW

Air On C	Heat Output (kW)	Air Off C	1.7	Water dp (kPa)	Heat Output (kW)	Air Off C	1.3	Water dp (kPa)	Heat Output (kW)	Air Off C	1	Water dp (kPa)	Connection size
			Water flow rate (l/s)				Water flow rate (l/s)				Water flow rate (l/s)		
-3	60	26	1.32	11	54	31	1.2	9.4	46	35	1	7.4	1.25"
3	55	29	1.22	9.6	50	35	1.1	8.3	43	38	0.96	6.6	
9	50	33	1.1	8.2	46	38	1	7.2	40	41	0.88	5.8	
15	45	37	0.97	7	41	41	0.92	6.2	36	44	0.8	5	
-3	50	21	0.61	3.4	45	26	0.56	2.9	39	29	0.48	2.33	1"
3	45	25	0.55	2.83	41	29	0.5	2.42	36	32	0.44	2.07	
9	40	28	0.49	2.37	37	32	0.45	2.06	32	35	0.39	1.72	
15	35	32	0.43	1.93	33	36	0.4	1.71	28	38	0.35	1.45	
-3	32	12	0.39	1.66	29	15	0.35	1.39	25	17	0.3	1.14	1"
3	27	16	0.33	1.28	25	19	0.3	1.10	21	20	0.26	0.92	
9	22	20	0.27	0.94	20	22	0.24	0.78	17	23	0.21	0.66	
15	17	23	0.2	0.59	15	24	0.19	0.54	14	26	0.16	0.43	

ECOSMART BOXER Size 5

Air Volume Flow rate (m³/s)

2 ROW

Air On C	Heat Output (kW)	Air Off C	2.1	Water dp (kPa)	Heat Output (kW)	Air Off C	1.8	Water dp (kPa)	Heat Output (kW)	Air Off C	1.4	Water dp (kPa)	Connection size
			Water flow rate (l/s)				Water flow rate (l/s)				Water flow rate (l/s)		
-3	94	34	2.1	12.9	86	36	1.9	11	72	39	1.6	8.2	2"
3	87	37	1.9	11.3	79	39	1.77	9.7	67	42	1.48	7.3	
9	80	40	1.78	9.8	73	42	1.63	8.5	61	45	1.36	6.4	
15	73	43	1.62	8.4	67	45	1.48	7.3	56	48	1.24	5.5	
-3	81	29	0.99	3.9	74	31	0.91	3.4	62	34	0.76	2.59	1.25"
3	74	32	0.91	3.4	68	34	0.83	3.05	57	37	0.69	2.23	
9	67	35	0.82	3.00	61	37	0.75	2.60	51	39	0.63	1.93	
15	60	38	0.73	2.51	55	40	0.67	2.19	46	42	0.56	1.61	
-3	54	18	0.66	2.15	49	19	0.6	1.84	41	21	0.5	1.35	1.25"
3	47	21	0.57	1.71	43	22	0.52	1.48	36	24	0.43	1.07	
9	39	24	0.48	1.31	36	25	0.43	1.10	30	26	0.36	0.81	
15	32	27	0.38	0.91	29	28	0.35	0.80	24	29	0.29	0.58	

ECOSMART BOXER Size 6

Air Volume Flow rate (m³/s)

2 ROW

Air On C	Heat Output (kW)	Air Off C	3.9	Water dp (kPa)	Heat Output (kW)	Air Off C	3	Water dp (kPa)	Heat Output (kW)	Air Off C	2	Water dp (kPa)	Connection size
			Water flow rate (l/s)				Water flow rate (l/s)				Water flow rate (l/s)		
-3	157	30	3.5	11.8	139	35	3.1	9.9	106	40	2.35	6.6	2"
3	144	34	3.2	10.4	128	38	2.85	8.8	98	43	2.17	5.9	
9	132	37	2.9	9.1	117	41	2.61	7.7	90	46	1.99	5.3	
15	119	40	2.6	7.9	106	44	2.36	6.7	81	48	1.8	4.6	
-3	131	25	1.6	3.9	116	29	1.42	3.3	89	33	1.1	2.28	1.5"
3	118	28	1.44	3.4	105	32	1.28	2.87	81	36	0.99	1.97	
9	106	31	1.29	2.92	94	35	1.15	2.47	72	38	0.88	1.67	
15	93	35	1.13	2.42	83	38	1	2.03	64	41	0.78	1.41	
-3	83	14	1	2.04	73	17	0.89	1.73	56	20	0.67	1.14	1.5"
3	70	18	0.85	1.63	62	20	0.75	1.36	47	22	0.57	0.91	
9	56	21	0.68	1.19	50	23	0.61	1.02	37	24	0.45	0.65	
15	42	24	0.51	0.80	37	25	0.45	0.66	25	25	0.31	0.39	

ECOSMART BOXER Size 7

Air Volume Flow rate (m³/s)

2 ROW

Air On C	Heat Output (kW)	Air Off C	4.8	Water dp (kPa)	Heat Output (kW)	Air Off C	4.2	Water dp (kPa)	Heat Output (kW)	Air Off C	3.2	Water dp (kPa)	Connection size
			Water flow rate (l/s)				Water flow rate (l/s)				Water flow rate (l/s)		
-3	201	31	4.5	13	189	34	4.2	11.7	166	40	3.7	9.6	2"
3	184	35	4.1	11.2	174	37	3.9	10.3	153	42	3.4	8.5	
9	168	38	3.7	9.8	158	40	3.5	9	139	45	3.1	7.5	
15	151	41	3.4	8.4	143	43	3.2	7.7	125	47	2.8	6.4	
-3	161	25	1.97	4	152	27	1.86	3.8	134	32	1.64	3.2	1.5"
3	145	28	1.77	3.5	137	30	1.67	3.3	121	34	1.48	2.66	
9	128	31	1.56	2.95	121	33	1.48	2.72	107	37	1.31	2.24	
15	111	34	1.36	2.43	106	36	1.29	2.24	93	39	1.14	1.85	
-3	96	13	1.16	1.95	91	15	1.1	1.79	80	18	0.97	1.47	1.5"
3	79	16	0.96	1.49	75	18	0.91	1.37	66	20	0.8	1.12	
9	61	19	0.74	1.04	58	20	0.7	0.95	50	22	0.61	0.77	
15	39	22	0.48	0.57	36	22	0.43	0.48	29	23	0.35	0.35	

For further assistance please call Nuair. Note: dp figures do not include 3 port valve. Approximately double these figures when valves are included.

*Please note: above tables are based on indicative selections. For more specific selection, contact Nuair.

SILENCER MODULES

Splitters are faced with perforated sheet lined to prevent particle migration and filled with high density mineral wool.

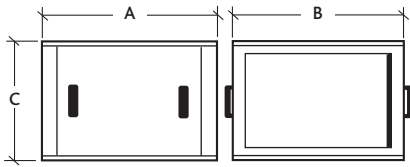

Unit Code	A	B	C	Weight (Kg)
ESBSIL3	900	800	800	95
ESBSIL4	900	1000	800	96
ESBSIL5	900	1000	1000	124
ESBSIL6	900	1300	1000	150
ESBSIL7	900	1300	1300	192

DYNAMIC ATTENUATION VALUES (at maximum velocity)

Length	125	250	500	1K	2K	4K	8K
900	6	8	18	22	20	16	15
1200	7	11	26	31	30	23	20

Note: silencer cross sectional area matches the Ecosmart Boxer unit.

WEATHER ROOF FOR ECOSMART BOXER

For further information please contact Nuair.

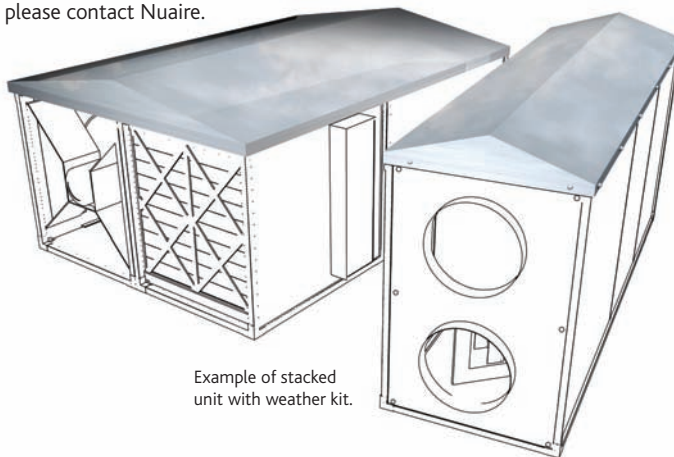

Example of horizontal unit with weather kit.

Example of stacked unit with weather kit.

MOTORISED DAMPERS

Opposed blade design with quick fit flanges. 240V Open/Shut model (B) for efficient back draught protection and 24V modulating version (M) for balancing and control.

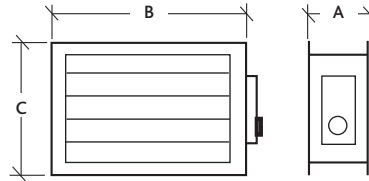

Unit	A	Weight (Kg)
ESBD3	165	19
ESBD4	165	23
ESBD5	165	28
ESBD6	165	30
ESBD7	165	34

Note: Dimensions B & C are to suit unit supplied.

Also available: motor open/spring return option. Code: ESBD* MO/SR.

FROST COIL = LPHW & ELECTRIC

600mm long section to suit unit size selected. For details contact Nuair.

VERTICAL HEAT EXCHANGER

A plate exchanger core assembly providing efficient heat transfer between supply and extract air streams. An integral drip tray is incorporated with a 22mm drain connection. The tray is insulated to prevent secondary condensation.

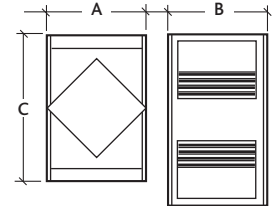

Unit	Length		Width		Height		Weight (Kg)
	A	B	B	C	C		
ESBHX3	1200	800	1600	210			
ESBHX4	1400	1000	1600	263			
ESBHX5	2200	1000	2000	360			
ESBHX6	2200	1300	2000	440			
ESBHX7	2500	1300	2600	594			

HORIZONTAL HEAT EXCHANGER

Heat exchanger complete with integral drop tray with a 22mm drain connection.

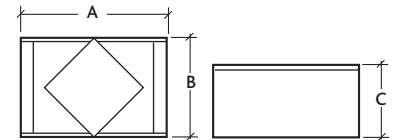

Unit	Length		Width		Height		Weight (Kg)
	A	B	B	C	C		
ESBHX3H	1200	1600	800	200			
ESBHX4H	1625	2000	800	280			
ESBHX5H	2000	2000	1000	360			
ESBHX6H	2200	2600	1000	600			
ESBHX7H	2200	2600	1300	594			

ESBBF2* - Available in a variety of lengths to suit unit sizes 1 - 7.

BASE FRAME

(Please contact Nuair for further details). Provided as standard on sizes 3 - 7. Optional extras on sizes 1 and 2.

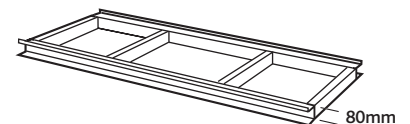

Z FACTORS FOR ANCILLARIES

Casing Module	3	4	5	6	7
Silencer	20	11	8	3.1	2
Damper	12	6.8	4.8	1.9	1.2
Frost coil LPHW	23	14	9.6	3.8	2.4
Frost coil electric	23	14	9.6	3.8	2.4
Weather cowl	12	6.8	4.8	1.9	1.2
Plate heat exchanger	117	68	48	1.9	12

For further ancillaries please refer to Ducting and Ancillaries section or call Nuair.

WIRING - ECOSMART BOXER SIZES 3 - 7
BMS MODES 1 AND 2

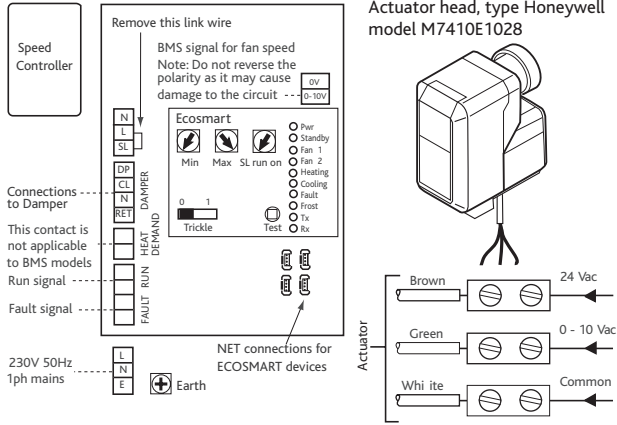

BMS MODES 3 TO 7

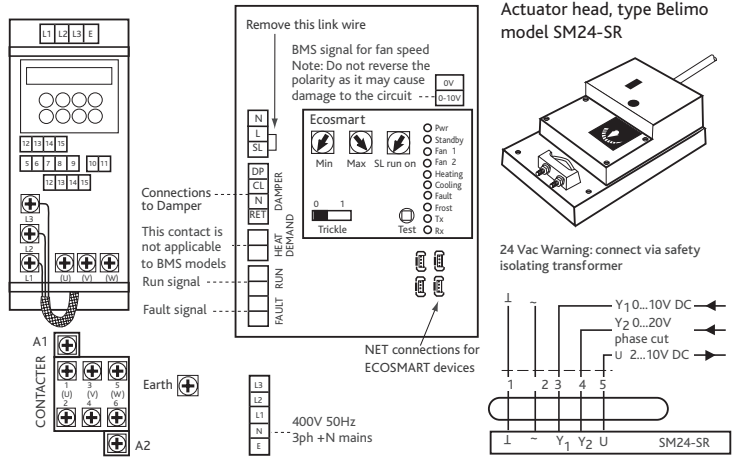

WIRING - ECOSMART BOXER SIZES 3 - 7
ESBHS3-L, ESBHS4-L, ESBHS5-L, ESBHS6-L AND ESBHS7,
ESBHS3-LD, ESBHS4-LD, ESBHS5-LD, ESBHS6-LD AND ESBHS7-LD

WIRING - ECOSMART BOXER SIZES 3 - 7
ESBHS3-LC, ESBHS4-LC, ESBHS5-LC, ESBHS6-LC
AND ESBHS7-LC

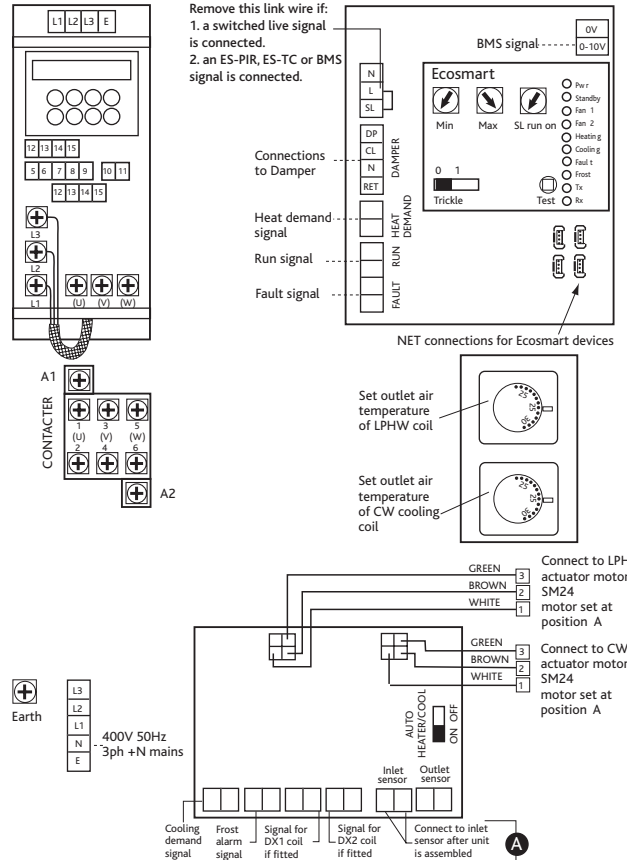
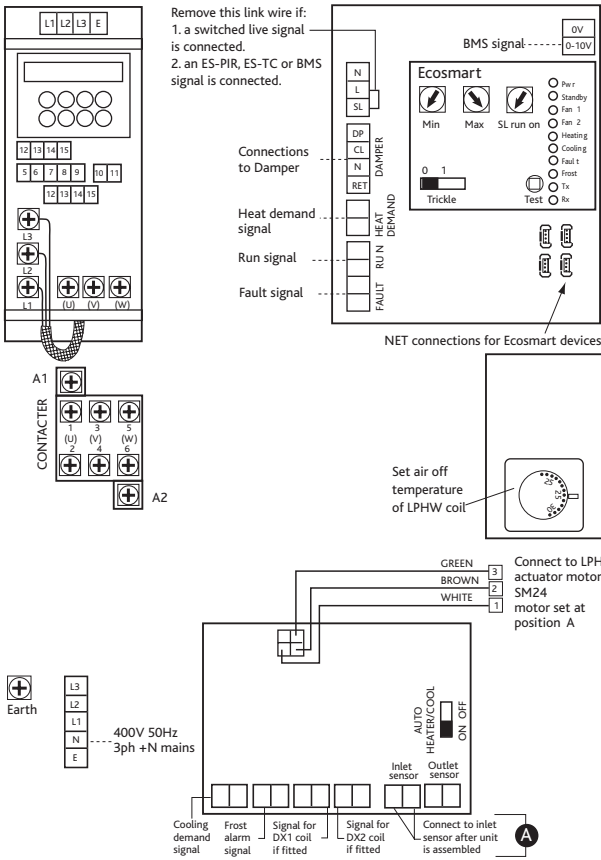

ESBHEX3, ESBHEX4, ESBHEX6 AND ESBHEX7

ESBHS3-E, ESBHS4-E, ESBHS5-E, ESBHS6-E AND ESBHS7-E

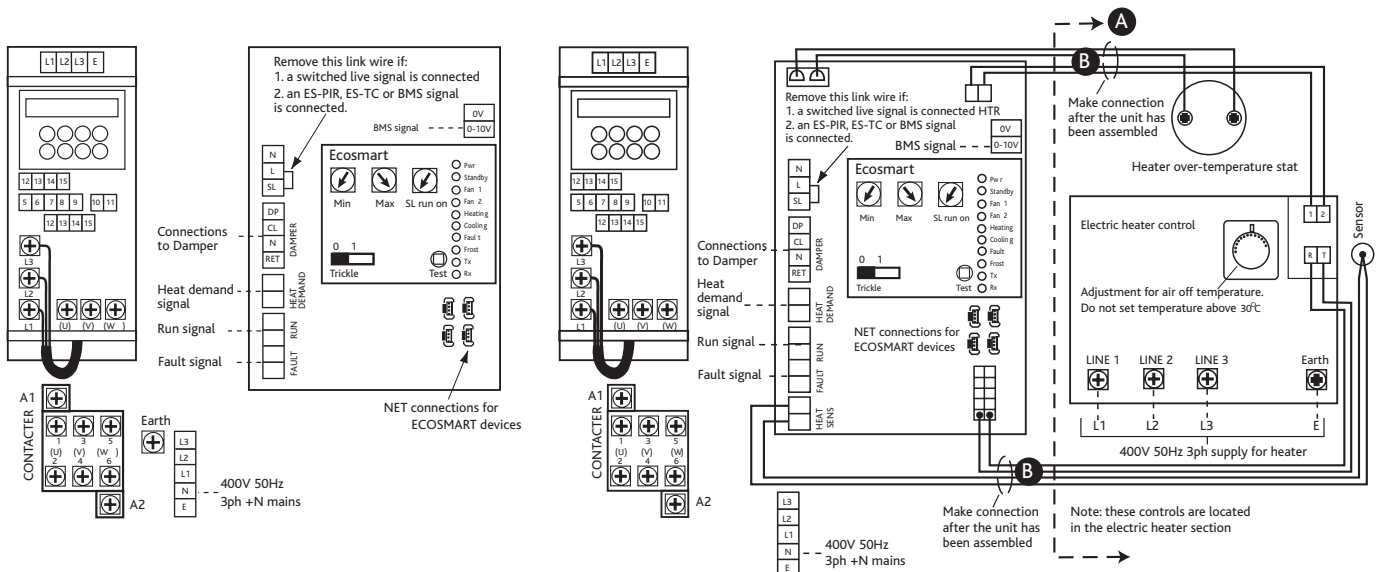

ECOSMART BOXER WITH CONSTANT PRESSURE CONTROLS

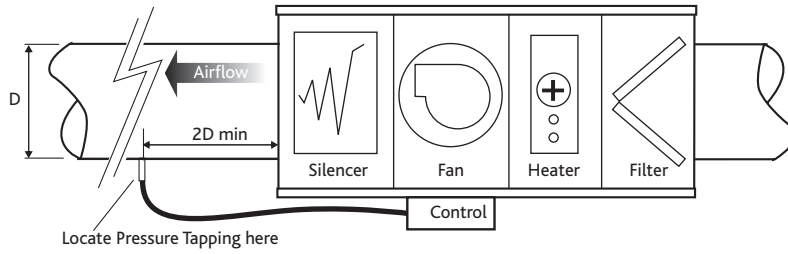

SUPPLY FANS SIZE 3 AND ABOVE

EXTRACT FANS SIZE 3 AND ABOVE

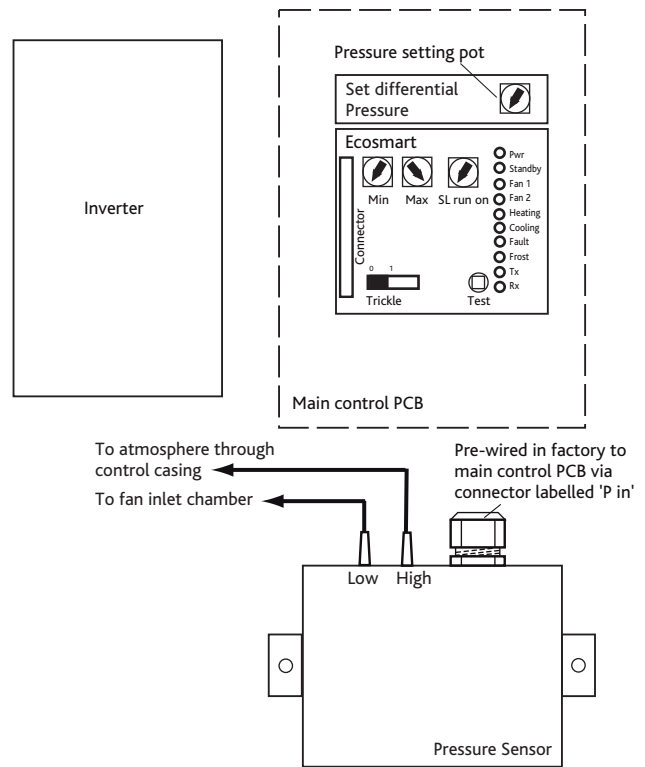
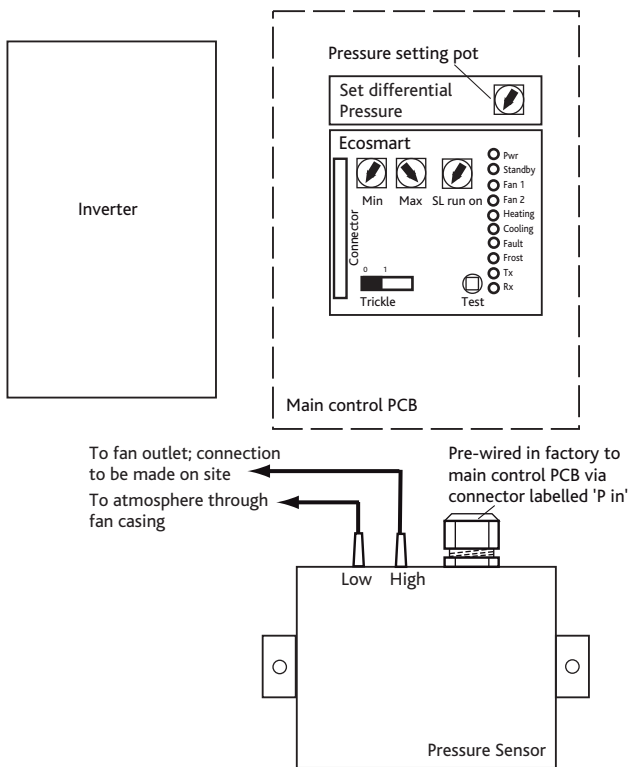

ECOSMART BOXER FAN CONTROL ONLY

Power requirements

Model	Flc fan only (1)	Electric heater max Kw	Fc heater (2)
BHSEX3FC, BHS3FC-L	4.6A		
BHS3FC-E	4.6A	27	38A
BHSEX4FC, BHS4FC-L	6.1A		
BHS4FC-E	6.1A	36	50A
BHSEX5FC, BHS5FC-L	7.8A		
BHS5FC-E	7.8A	54	75A
BHSEX6FC, BHS6FC-L	8.2A		
BHS6FC-E	8.2A	54	75A
BHSEX7FC, BHS7FC-L	11.4A		
BHS7FC-E	11.4A	54	75A

Note: (1) Sizes 1 and 2 fans are rated at 230V ac, 50Hz single phase. All other sizes are rated at 400V ac 50 Hz 3 phase.

(2) All electric heaters are rated at 400V ac 50 Hz 3 phase.

- i There are no inrush starting currents quoted because the Ecosmart control incorporates a soft starting speed control feature.
- ii. The inverters are preset to match the fan requirements. Under normal circumstances it should not be necessary to adjust them.
- iii. Pay particular attention to the model type, recorded on the product rating plate and connect as follows.

TYPICAL ELECTRIC HEATER WIRING

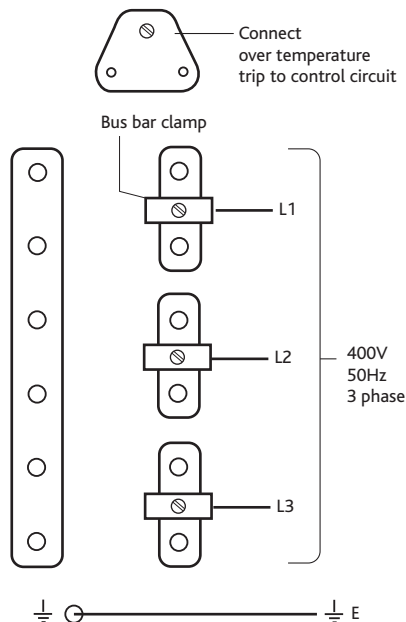

SIZES 3 TO 7

Note: Inter connections between circuit boards and inverter/contactors are made in the factory.

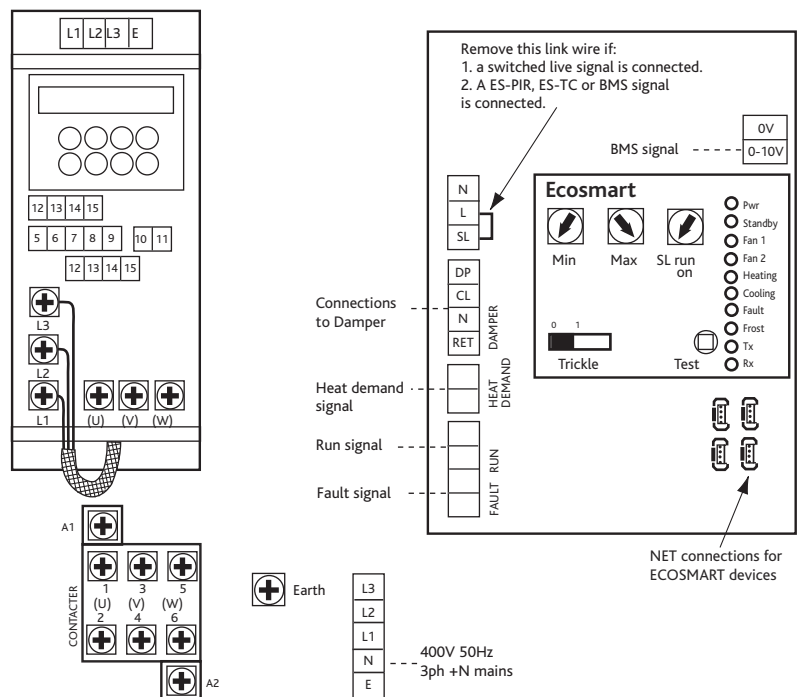

CONSULTANTS SPECIFICATION

ECOSMART BOXER UNITS SIZE 3 TO 7

AIR HANDLING UNIT SPECIFICATION

The Air Handling Unit shall be configured and arranged as detailed on the drawings and in accordance with the schedule of equipment. The units shall be manufactured from a highly rigid pentapost framework with 25mm double skinned infill panels. The panels shall contain inert high density infill. Panel materials are heavy gauge Aluzinc corrosion resistant steel. The units shall provide exceptional thermal and acoustic insertion. The general construction is to class A leakage.

The fan impeller and motor shall be selected to provide the most energy efficient solution conforming to part L regulations and shall be direct or belt drive with IE2 high efficiency motors to BS5000 as standard. The fan impeller shall be a high efficiency forward or backward curved centrifugal design, manufactured in galvanised steel.

The Fan unit shall have a 5 year warranty.

The unit and ancillaries shall be of the Ecosmart Boxer type as manufactured by Nuaire Ltd.

All other components shall be in accordance with the manufacturer's specification.

CONTROL SPECIFICATION

The Air Handling Unit shall be supplied with one of the following control options:-

1. ECOSMART CONTROLS -

The compact Ecosmart control system complete with all necessary controls to facilitate the operation of the ventilation system. It shall be complete with an integral factory fitted Ecosmart PCB which will control the fan unit within the desired design parameters and provide the interface between all external control devices and the unit itself.

The Air Handling Unit shall have the following energy saving components integrally mounted, pre-wired to interface with the purpose made PCB, all components pre-wired, configured and factory fitted by the manufacturer: -

- Integral Frequency inverter/speed controller.
- Integral maximum and minimum speed adjustment for commissioning.
- Integral adjustable run on timer.
- Integral BMS interfaces – summer/winter switching, heating control, 0-10V speed adjustment.
- Volt free failure and status indication.
- Integral air off temperature adjustment.
- Facility for remote temperature control.
- Integral background ventilation switch (trickle switch).
- Multiple IDC sockets for interconnection of sensors or fans using pre-plugged 4-core low voltage cable.
- Volt free frost alarm/heat demand interface.
- Frost protection/hold off stat.

ECOSMART SYSTEM OPERATION

The Ecosmart controls will enable the unit to automatically vary its speed as it receives signals from one of the interconnected sensors. When the signal is received the fan shall either increase speed gradually until the required level is achieved or it will work on a trickle and boost principle. This will then move the fan duty point from trickle/background ventilation rate to the required boost ventilation rate. Both the trickle and boost rates are infinitely variable, easy to adjust and remove the need of a main balancing damper.

2. BMS INTERFACES

The fan unit shall be provided with the following integrated BMS interfaces

- 0 - 10 volt contacts to provide a full BMS interface. This will enable the following functions:-
 - Switch the unit on/off.
 - Switch from low speed to high speed.
 - Full speed control facility.
 - Switch the heating function on/off.
 - Switch the cooling function on/off.
- 2 No. Volt free contacts to provide fan run and failure indication to provide system status.
- An integrated commissioning/speed control to accurately commission the system, with minimum and maximum speeds easily adjusted via a miniature dial, as recommended in Part L. This will enable the unit to be configured to run between set parameters thus saving motor power and limiting noise.
- Commissioning set up - The fan unit shall be provided with an integrated commissioning/speed control to accurately commission the system, as recommended in Part L, minimum and maximum speeds easily adjusted via miniature dial. The commissioning set up facility directly controls the integrated speed control/frequency inverter.

3. NO CONTROL IS AVAILABLE

(Example code BHS7NC-E).

COIL TYPES, HX AND CONTROLS

The control for the coils shall be fully integrated and shall maintain a constant off coil temperature. The system shall have frost protection which shall, at temperatures below 4 degrees C, fully open the 3-port valve and only start the fan when the temperature at the filter has risen above the designated set point. Unit to have contacts which will act as frost alarm and/or signal boiler to switch on.

CONSULTANTS SPECIFICATION

HEATING COILS - LOW PRESSURE HOT WATER

The Low Pressure Hot Water heating coil shall be manufactured from copper tubing with high efficiency aluminium fins contained within a galvanised steel frame, shall be factory fitted with a 3-port motorised diverting valve assembly comprising the 3-port valve, double regulating valve, drain cocks actuator controlling the 3-port valve shall be control via the on-board PCB by the off coil temperature sensor. All components pre-piped, assembled and tested by the manufacturers.

HEATING COILS - ELECTRIC

The Electric Heater Battery shall be factory fitted and pre-wired to an integral closed loop thyristor control. The heat output can be configured on site to suit the specific requirements.

COOLING COILS - CHILLED WATER

The Chilled Water Coil shall be manufactured from copper tubing with high efficiency aluminium fins contained within a galvanised steel frame, it shall be factory fitted with a 3-port motorised diverting valve assembly comprising the 3-port valve, drain cocks and air vents. The actuator controlling the 3-port valve shall be control via the on-board PCB by the off coil temperature sensor. Coil supplied complete with an insulated condensate tray and moisture eliminator. All components pre-piped, assembled and tested by the manufacturer.

COOLING COILS – DX COILS

The DX Coil shall be manufactured from copper tubing with high efficiency aluminium fins and droplet eliminator contained within a galvanised steel frame. The coil shall be filled with dry nitrogen with the pipe connections capped. It shall be factory fitted and tested by the AHU manufacturer.
Note: Fan control only example code is BHS7FC-LD.

HEAT EXCHANGER

The cross flow heat exchanger shall be complete with a motorised summer bypass; this will be activated when the heating, cooling or ventilation switch on the user control is switched to the ventilation position.

The Ecosmart controlled fan unit shall have a 5 year warranty.
Non Ecosmart fan controlled units will have a 3 year warranty.

All equipment shall be as manufactured by Nuair Ltd.

*Suitable for 95% RH non condensing.